



INDOOR LIGHTING

HIGH BAYS | WET LOCATION | COMMERCIAL



Independence Series High Bay

LUMEN SELECTABLE

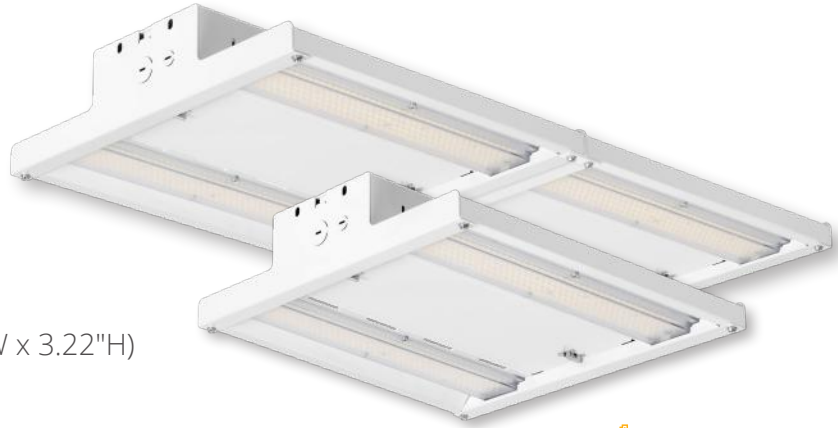

- Ultra compact (14"W x 3.22"H)
- Easy to install
- Smooth & uniform light



ORDERING INFORMATION

IHB	S	12-24L					
PRODUCT SERIES	SELECTABLE	LUMEN PACKAGE	LENS OPTION	MODULES	COLOR TEMP.	VOLTAGE	OPTIONS
IHB = Independence High Bay	Blank = Fixed Lumens S = Selectable Lumens	12-24L = 12,000, 18,000, 24,000 Selectable Lumens* 12L = 12,000 Lumen Package* 15L = 15,000 Lumen Package* 18L = 18,000 Lumen Package* 24L = 24,000 Lumen Package* 30L = 30,000 Lumen Package 36L = 36,000 Lumen Package** 48L = 48,000 Lumen Package** 60L = 60,000 Lumen Package** * - Only available in Single Module ** - Only available in Double Module	Blank = Clear D = Diffuse N = Narrow ¹ ¹ - Selectable Lumen Not Available in Narrow	Blank = Single Module 2 = Double Module 3 = Triple Module	4K = 4000K 45K = 4500K 5K = 5000K	Blank = 120-277	xC* = x' Cord (No Plug) xT* = x' 120V Cord & Plug xE* = x' 208V Cord & Plug xF* = x' 240V Cord & Plug xS* = x' 277V Cord & Plug EB = Emergency Back-Up W = Wire Guard M = Motion Sensor (120/277v)** M2= Motion Sensor (208/240/480v)** *x = 3 for 3'; 6 for 6'; 10 for 10'; and 20 for 20' ** - M and M2 are end mount only

PERFORMANCE DATA

UNIT	MODULES	CRI	4000K CCT		4500K CCT		5000K CCT		WATTAGE	REPLACES UP TO
			DELIVERED LUMENS	EFFICACY (LPW)	DELIVERED LUMENS	EFFICACY (LPW)	DELIVERED LUMENS	EFFICACY (LPW)		
SELECTABLE										
Clear Lens										
12L-24L	Single	80	12,967	158	12,967	158	13,011	157	83	400W MH
	Single	80	19,045	152	19,045	152	19,110	153	125	
	Single	80	23,843	146	23,843	146	23,924	147	163	
15L-30L	Single	80	14,135	158	14,135	158	14,435	158	90	400W MH
	Single	80	21,037	152	21,037	152	21,483	156	138	
	Single	80	27,560	145	27,560	145	28,145	148	190	
Diffused Lens										
12L-24L	Single	80	11,587	141	11,523	139	11,523	139	83	400W MH
	Single	80	16,954	136	16,860	135	16,860	135	125	
	Single	80	21,281	132	21,163	131	21,163	131	162	
15L-30L	Single	80	12,931	144	12,931	144	13,241	145	90	400W MH
	Single	80	19,317	140	19,317	140	19,780	143	138	
	Single	80	25,353	133	25,353	133	25,961	136	190	
Narrow Lens										
15L-30L	Single	80	13,463	150	13,463	150	13,721	150	90	400W MH
	Single	80	20,006	145	20,006	145	20,389	147	138	
	Single	80	26,318	138	26,318	138	26,822	141	190	
FIXED										
Clear Lens										
IHB12L	Single	80	12,528	152	12,528	159	12,597	160	83	175W MH
IHB15L	Single	80	16,144	154	16,144	152	16,513	157	105	250W MH
IHB18L	Single	80	18,597	153	18,597	153	19,022	156	122	250W MH
IHB24L	Single	80	23,910	148	23,899	148	23,899	148	162	400W MH
IHB30L	Single	80	29,550	159	29,550	159	30,370	166	186	400W MH
IHB30L2	Double	80	28,347	160	28,347	160	29,134	165	177	400W MH
IHB36L2	Double	80	37,194	153	37,194	153	38,044	156	244	1000W MH
IHB48L2	Double	80	47,820	148	47,798	148	47,798	148	324	1000W MH
IHB60L2	Double	80	59,100	159	59,100	159	60,740	166	371	1000W MH
IHB72L3	Triple	80	71,730	148	71,697	148	71,697	148	485	1000W MH
IHB90L3	Triple	80	88,650	159	88,650	159	91,110	166	557	1500W MH
Diffused Lens										
IHB12LD	Single	80	11,358	138	11,358	138	11,421	139	82	175W MH
IHB15LD	Single	80	14,567	140	14,567	140	14,949	143	105	250W MH
IHB18LD	Single	80	16,767	137	16,767	137	17,207	141	122	250W MH
IHB24LD	Single	80	21,506	133	21,404	136	21,404	136	162	400W MH
IHB30LD	Single	80	26,470	143	26,470	143	27,343	149	185	400W MH
IHB30LD2	Double	80	25,537	145	25,537	145	26,379	149	177	400W MH
IHB36LD2	Double	80	33,534	137	33,534	137	34,414	141	244	1000W MH
IHB48LD2	Double	80	43,012	133	42,808	136	42,808	136	323	1000W MH
IHB60LD2	Double	80	52,940	143	52,940	143	54,686	149	371	1000W MH
IHB72LD3	Triple	80	64,518	133	64,212	133	64,212	133	486	1000W MH
IHB90LD3	Triple	80	79,410	143	79,410	143	82,029	149	557	1500W MH
Narrow Lens										
IHB12LN	Single	80	11,089	143	11,089	143	11,501	145	79	175W MH
IHB15LN	Single	80	14,652	140	14,652	140	15,196	145	105	250W MH
IHB18LN	Single	80	16,766	138	16,766	138	17,389	143	122	250W MH
IHB24LN	Single	80	21,363	132	21,363	132	21,491	133	162	400W MH
IHB30LN	Single	80	26,488	143	26,488	143	27,097	148	185	400W MH
IHB30LN2	Double	80	25,400	144	25,400	144	25,552	145	177	400W MH
IHB36LN2	Double	80	33,532	138	33,532	138	34,778	143	243	1000W MH
IHB48LN2	Double	80	42,726	132	42,726	132	42,982	133	324	1000W MH
IHB60LN2	Double	80	52,976	143	52,976	143	54,194	148	371	1000W MH
IHB72LN3	Triple	80	64,089	132	64,089	132	64,473	133	486	1000W MH
IHB90LN3	Triple	80	79,464	143	79,464	143	81,291	148	556	1500W MH

THE INFORMATION YOU NEED - ALL IN ONE PLACE

Visit www.atlasled.com or scan QR code more information, including cut sheets, case studies, installation videos, instruction sheets, savings information, IES files, lighting calculation tools and more.



Classic Series Linear LED High Bay NARROW BODY



- 20-gauge steel housing
- 91% efficiency high-transmission lens*
- Tool-free driver compartment



ORDERING INFORMATION

ILH	2	9L	L		
PRODUCT SERIES	FIXTURE LENGTH	LUMEN PACKAGE	LENS OPTION	COLOR TEMP.	OPTIONS
ILH = Slim LED Linear High Bay ILHS = Slim LED Linear High Bay	2 = 2 Feet 4 = 4 Feet	9L = 9,000 Lumen Package 12L = 12,000 Lumen Package 15L = 15,000 Lumen Package 18L = 18,000 Lumen Package 24L = 24,000 Lumen Package 30L = 30,000 Lumen Package	Blank = Without Lens L = With Lens	Blank = 4500K 4K = 4000K 5K = 5000K	xC* = 3' Cord (No Plug) xT* = 3' 120V Cord & Plug xE* = 3' 208V Cord & Plug xF* = 3' 240V Cord & Plug xS* = 3' 277V Cord & Plug F = Inline Fusing EB = Emergency Back-Up M = Motion Sensor P = Pendant Mount IC = Integrated Control 4 = 480V Driver *x = 3 for 3' Cord; 6 for 6' cord, 10 for 10' cord; and 20 for 20' cord lengths

PERFORMANCE DATA

UNIT	FIXTURE LENGTH	CRI	4000K CCT		4500K CCT		5000K CCT		WATTAGE	REPLACES UP TO
			DELIVERED LUMENS	EFFICACY (LPW)	DELIVERED LUMENS	EFFICACY (LPW)	DELIVERED LUMENS	EFFICACY (LPW)		
Without Lens										
ILH29L	2'	80	10,300	139	10,300	139	10,300	139	74	4L T8 FL
ILHS212L	2'	80	12,421	151	12,303	146	12,503	152	84	175W MH
ILHS215L	2'	80	15,277	154	14,915	148	15,277	154	101	250W MH
ILH415L	4'	80	15,819	148	15,267	148	15,267	153	103	250W MH
ILH418L	4'	80	18,270	145	17,632	139	17,632	139	126	250W MH
ILHS424L	4'	80	26,102	156	25,191	150	25,191	150	167	400W MH
ILHS430L	4'	80	31,151	153	30,064	147	30,064	147	204	400W MH
With Lens										
ILH29LL	2'	80	9,631	130	9,631	130	9,635	131	74	4L T8 FL
ILHS212LL	2'	80	11,580	140	11,485	137	11,580	140	84	175W MH
ILHS215LL	2'	80	14,353	144	13,841	137	14,353	144	101	250W MH
ILH415LL	4'	80	14,914	145	14,393	140	14,393	140	103	250W MH
ILH418LL	4'	80	17,231	137	16,630	132	16,630	132	126	250W MH
ILHS424LL	4'	80	24,698	148	23,836	142	23,836	142	167	400W MH
ILHS430LL	4'	80	29,500	145	28,470	139	28,470	139	204	400W MH

*The majority of Atlas Lighting Products are assembled in USA facilities by an American Workforce utilizing both Domestic and Foreign components. | *Qualifies for Buy American under ARRA

Classic Series Linear LED High Bay WIDE BODY



- 20-gauge steel housing
- 91% efficiency high-transmission lens*
- Tool-free driver compartment



ORDERING INFORMATION

ILH	2	18L	L		
PRODUCT SERIES	FIXTURE LENGTH	LUMEN PACKAGE	LENS OPTION	COLOR TEMP.	OPTIONS
ILH = LED Linear High Bay	2 = 2 Feet 4 = 4 Feet	18L = 18,000 Lumen Package 24L = 24,000 Lumen Package 30L = 30,000 Lumen Package 36L = 36,000 Lumen Package 48L = 48,000 Lumen Package	Blank = Without Lens L = With Lens	Blank = 4500K 4K = 4000K 5K = 5000K	xC* = 3' Cord (No Plug) xT* = 3' 120V Cord & Plug xE* = 3' 208V Cord & Plug xF* = 3' 240V Cord & Plug xS* = 3' 277V Cord & Plug F = Inline Fusing EB = Emergency Back-Up M = Motion Sensor P = Pendant Mount IC = Integrated Control 4 = 480V Driver <i>*x = 3 for 3' Cord; 6 for 6' cord, 10 for 10' cord; and 20 for 20' cord lengths</i>

PERFORMANCE DATA

UNIT	FIXTURE LENGTH	CRI	4000K CCT		4500K CCT		5000K CCT		WATTAGE	REPLACES Up To
			DELIVERED LUMENS	EFFICACY (LPW)	DELIVERED LUMENS	EFFICACY (LPW)	DELIVERED LUMENS	EFFICACY (LPW)		
Without Lens										
ILH218L	2'	80	20,240	139	20,240	139	20,240	139	146	4L T8 FL
ILH224L	2'	80	25,342	152	25,870	138	25,342	152	167/187	175W MH
ILH230L	2'	80	30,716	154	n/a	n/a	30,716	154	199	250W MH
ILH436L	4'	80	37,295	156	35,993	151	35,993	151	239	250W MH
ILH448L	4'	80	46,352	151	44,734	146	44,734	146	307	250W MH
With Lens										
ILH218LL	2'	80	18,870	130	18,870	130	18,870	130	145	4L T8 FL
ILH224LL	2'	80	23,757	143	24,230	130	23,757	143	167/187	175W MH
ILH230LL	2'	80	28,757	144	n/a	n/a	28,757	144	199	250W MH
ILH436LL	4'	80	35,162	147	33,935	142	33,935	147	239	250W MH
ILH448LL	4'	80	43,528	142	42,009	137	42,009	137	306	400W MH

THE INFORMATION YOU NEED - ALL IN ONE PLACE

Visit www.atlasled.com or scan QR code more information, including cut sheets, case studies, installation videos, instruction sheets, savings information, IES files, lighting calculation tools and more.



Origin Series Die Cast High Bay

FULLY SELECTABLE
- ☀️ + LUMEN • CCT



- Replace up to 6 standard high bays with just 1
- Durable die-cast aluminum construction
- Built-in Connect Control Port requires no wiring to connect the IRH-MOT sensor



ORDERING INFORMATION

ORHB	S	22-30L				
PRODUCT SERIES	SELECTABLE	LUMEN PACKAGE	COLOR TEMP.	CONTROLS	VOLTAGE	FIXTURE COLOR
ORHB = Die Cast High Bay	S = Selectable	12-21L = 12,000 - 21,000 Lumens Selectable 22-30L = 22,000 - 30,000 Lumens Selectable	blank = Selectable 4000K, 5000K	Blank = Dimming (0-10V)	Blank = 120-277	Blank = White

PERFORMANCE DATA

HOUSING	UNIT	CRI	SELECTABLE 4000K CCT		SELECTABLE 5000K CCT		WATTAGE	REPLACES UP TO
			DELIVERED LUMENS	EFFICACY (LPW)	DELIVERED LUMENS	EFFICACY (LPW)		
SELECTABLE								
ORHBS	12-21L	80	15,429	140	15,487	141	110	175W MH
			17,471	135	17,687	136	130	250W MH
			20,381	137	20,817	139	152	400W MH
	22-30L	80	22,493	151	23,012	152	150	400W MH
			24,259	148	25,024	150	165	400W MH
			30,609	138	31,221	141	222	400W MH

Scan QR code above for ordering format and more detailed information

OPTIONS AND ACCESSORIES

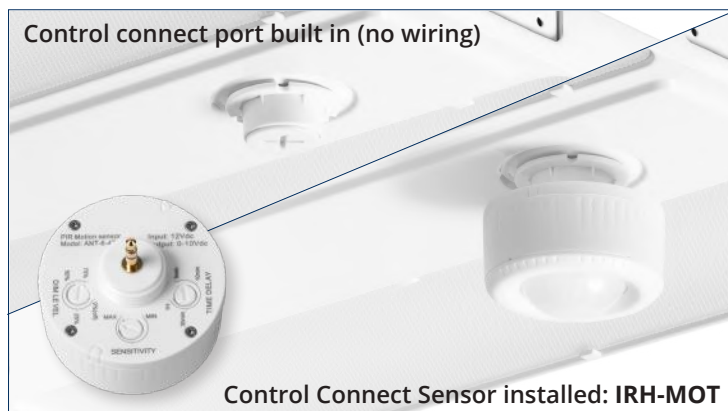

FIELD INSTALLABLE (purchased separately)

CATALOG #	DESCRIPTION
ORHBEM16	16W, 1,600 Lumen emergency back up kit
ORHBSPMK	Pendant mount kit for ORHBS

ORHBS Pendant Mount

CATALOG#	DESCRIPTION
ORHBSPMK	Pendant Mount Adapter Kit; Fits 3/4" NPT

Controls:

Pre-wired with control connect port built in. No wiring required.
Sensor 3 levels of control: Time (3-60 mins), Sensitivity and Dimming (0-75%)
No remote needed. Setting stay if power is interrupted.

Origin Series Round LED High Bay

FULLY SELECTABLE
- ☀️ + LUMEN • CCT 🌈



- Replace up to 6 standard high bays with just 1
- Durable die-cast aluminum construction
- Built-in Connect Control Port requires no wiring to connect the IRH-MOT sensor

ORDERING INFORMATION

IRH	S	18-30L			
PRODUCT SERIES	SELECTABLE	LUMEN PACKAGE	VOLTAGE	COLOR TEMP.	HOUSING COLOR
IRH = LED Industrial Round High Bay	S = Selectable	18-30L = 18,000 - 30,000 Selectable Lumen	Blank = 120-277V 4 = 480V	blank = Selectable (4000K, 4500K, 5000K)	Blank = Black

PERFORMANCE DATA

HOUSING	UNIT	CRI	SELECTABLE 4000K CCT		SELECTABLE 4500K CCT		SELECTABLE 5000K CCT		WATTAGE	REPLACES UP TO
			DELIVERED LUMENS	EFFICACY (LPW)	DELIVERED LUMENS	EFFICACY (LPW)	DELIVERED LUMENS	EFFICACY (LPW)		
IRHS	18-30L	80	18,090	134	20,790	154	18,765	139	135	175W MH
		80	24,120	134	27,720	154	25,020	139	180	250W MH
		80	30,742	123	34,253	144	31,535	125	238	400W MH

Scan QR code above for ordering format and more detailed information

OPTIONS AND ACCESSORIES

Motion Sensors

	CATALOG#	DESCRIPTION
	IRH-MOT	Control Connect Sensor (120, 277V) - Provides multi-level control based on motion - Controls 0-10 VDC LED drivers - 3 levels of control: Time (3-60 mins), Sensitivity and Dimming (0-75%) - No remote needed. Settings stay if power is interrupted.

IRH Pendant Mount

	CATALOG#	DESCRIPTION
	IRH-PMK	Pendant Mount Adapter Kit; Fits 3/4" NPT

Optical Accessories

	CATALOG#	DESCRIPTION
	RHB16SAR	Spun Aluminum Reflector
	RHB16FGC	16" Flat Glass and Clamp Band
	RHB16WG	16" Wireguard
	RHB16PAR	Prismatic Acrylic Refractor
	RHB16CLC	16" Conical Lens and Clamp Band

THE INFORMATION YOU NEED - ALL IN ONE PLACE

Visit www.atlasled.com or scan QR code more information, including cut sheets, case studies, installation videos, instruction sheets, savings information, IES files, lighting calculation tools and more.



Classic Series Linear LED Wet Location NARROW BODY



LUMEN SELECTABLE
- ☀️ +



- One-piece high-impact durable housing
- Injection-molded frosted acrylic lens
- IP65/IP66/IP67 rating



ORDERING INFORMATION

ILW		48LED	4	D		
PRODUCT SERIES	SELECTABLE	WATTAGE LUMENS	FIXTURE LENGTH	BODY STYLE	COLOR TEMP.	OPTIONS
ILW = LED Linear Wet Location	Blank = Fixed	25LED = 25 System Watts ¹ 30LED = 30 System Watts ² 48LED = 48 System Watts ² 76LED = 76 System Watts ³ 98LED = 98 System Watts ³ <i>¹2 Feet only ²4 Feet only ³8 Feet only</i>	2 = 2 Feet 4 = 4 Feet 8 = 8 Feet	D = Narrow Body	Blank = 4500K 4K = 4000K 5K = 5000K	xC* = 3' Cord (No Plug) EB = Emergency Back-Up ⁴ L = SS Latches 4 = 480V Driver CL = Clear Lens M = Motion (120/277) PG = Parking Garage ⁵ <i>*x = 3 for 3' Cord; 6 for 6' cord, 10 for 10' cord; and 20 for 20' cord lengths ⁴Not available on 2ft Unit ⁵48 Watt only</i>
	S = Selectable	4-8L = 4,000-8,000 Lumens Selectable ² 7-13L = 7000 - 13000 Lumens Selectable ³ <i>²4 Feet only ³8 Feet only</i>				

PERFORMANCE DATA

UNIT	FIXTURE LENGTH	CRI	4000K CCT		4500K CCT		5000K CCT		WATTAGE	REPLACES Up To
			DELIVERED LUMENS	EFFICACY (LPW)	DELIVERED LUMENS	EFFICACY (LPW)	DELIVERED LUMENS	EFFICACY (LPW)		
SELECTABLE										
Frosted Lens										
4-8L	4'	80	4,027	147	4,027	147	3,998	146	27	2L T8 FL
	4'	80	5,912	145	5,912	145	5,870	144	41	2L T5 FL
	4'	80	7,889	140	7,889	140	7,833	140	56	4L T8 FL
7-13L	8'	80	6,846	154	6,824	153	6,824	153	45	4L T8 FL
	8'	80	10,302	153	10,269	152	10,269	152	68	4L T5 FL
	8'	80	13,863	146	13,819	146	13,819	146	95	4L T5 FL
FIXED										
Frosted Lens										
ILW25LED	2'	80	4,455	142	4,455	142	4,624	144	32	70W MH
ILW30LED	4'	80	4,270	144	4,270	144	4,307	143	30	2L T5 FL
ILW48LED	4'	80	7,093	149	7,047	147	7,047	147	48	4L T8 FL
ILW76LED	8'	80	11,581	154	11,506	153	11,506	153	75	4L T5 FL
ILW98LED	8'	80	14,067	150	13,976	149	13,976	149	94	4L T5 FL

Classic Series Linear LED Wet Location WIDE BODY

LUMEN SELECTABLE



- One-piece high-impact durable housing
- Injection-molded frosted acrylic lens
- IP65/IP66/IP67 rating



ORDERING INFORMATION

ILW	S	13-27L	4	WD		
PRODUCT SERIES	SELECTABLE	WATTAGE LUMENS	FIXTURE LENGTH	BODY STYLE	COLOR TEMP.	OPTIONS
ILW = LED Linear Wet Location	Blank = Fixed	76LED = 76 System Watts ¹ 98LED = 98 System Watts 130LED = 130 System Watts 190LED = 190 System Watts ² <i>¹2 Feet only ²4 Feet only</i>	2 = 2 Feet 4 = 4 Feet	WD = Wide Body	Blank = 4500K 4K = 4000K 5K = 5000K	xC* = 3' Cord (No Plug) CL = Clear Lens EB = Emergency Back-Up 4 = 480V Driver M = Motion (120/277) SP = Surge Protection <i>*x = 3 for 3' Cord; 6 for 6' cord, 10 for 10' cord; and 20 for 20' cord lengths</i>
	S = Selectable	13-27L = 13,000-27,000 Lumens Selectable ² <i>²4 Feet only</i>	4 = 4 Feet			

PERFORMANCE DATA

UNIT	FIXTURE LENGTH	CRI	4000K CCT		4500K CCT		5000K CCT		WATTAGE	REPLACES UP TO
			DELIVERED LUMENS	EFFICACY (LPW)	DELIVERED LUMENS	EFFICACY (LPW)	DELIVERED LUMENS	EFFICACY (LPW)		
SELECTABLE										
Frosted Lens										
13-27L	4'	80	12,863	149	12,840	149	12,840	149	86	4L T5 FL
	4'	80	19,377	149	19,342	149	19,342	149	130	6L T5 FL
	4'	80	26,320	144	26,272	143	26,272	143	184	6L T5 FL
Clear Lens										
13-27L	4'	80	12,863	149	12,840	149	12,840	149	86	4L T5 FL
	4'	80	19,377	149	19,342	149	19,342	149	130	6L T5 FL
	4'	80	26,320	144	26,272	143	26,424	144	184	6L T5 FL
FIXED										
Clear Lens										
76LED2WD	2'	80	10,380	149	10,380	149	10,380	149	75	4L T5 FL
98LED2WD	2'	80	13,570	143	13,570	143	13,570	143	95	4L T5 FL
130LED2WD	2'	80	16,930	132	16,930	132	16,930	132	129	6L T5 FL
98LED4WD	4'	80	14,033	147	14,033	147	14,130	148	96	4L T5 FL
130LED4WD	4'	80	17,821	142	17,821	142	17,621	140	126	6L T5 FL
190LED4WD	4'	80	27,480	144	27,480	144	27,480	144	191	6L T5 FL

THE INFORMATION YOU NEED - ALL IN ONE PLACE

Visit www.atlasled.com or scan QR code more information, including cut sheets, case studies, installation videos, instruction sheets, savings information, IES files, lighting calculation tools and more.



Potomac Series

Linear Wet Location

RETROFIT KITS



- Installs in less than 5 minutes
- Easy upgrade to LED with gear tray retrofit
- Reduce power consumption up to 50%



ORDERING INFORMATION

ILWRK	98LED	4	WD		
PRODUCT SERIES	WATTAGE	FIXTURE LENGTH	BODY STYLE	COLOR TEMP.	OPTIONS
ILWRK = LED Linear Wet Location Retrofit Kit	30LED = 30 System Watts ¹ 48LED = 48 System Watts ¹ 76LED = 76 System Watts ² 98LED = 98 System Watts ^{2,3} 130LED = 130 System Watts ³ 190LED = 190 System Watts ³	4 = 4 Feet 8 = 8 Feet	D = Narrow Body WD = Wide Body	Blank = 4500K 4K = 4000K 5K = 5000K	EB = Emergency Back-Up L = SS Latches* 4 = 480V Driver <i>*Narrow only</i>
	¹ 4 Feet Narrow only				
	² 8 Feet Narrow only				
	³ 4 Feet Wide only				

PERFORMANCE DATA

UNIT	FIXTURE LENGTH	CRI	4000K CCT		4500K CCT		5000K CCT		WATTAGE	REPLACES UP TO
			DELIVERED LUMENS	EFFICACY (LPW)	DELIVERED LUMENS	EFFICACY (LPW)	DELIVERED LUMENS	EFFICACY (LPW)		
ILWRK30LED4D	4'	80	4,270	142	4,270	142	4,307	143	30	2 Lamp T8
ILWRK48LED4D	4'	80	7,093	148	7,047	148	7,047	148	48	2 Lamp T5
ILWRK76LED8D	8'	80	11,581	154	11,506	153	11,506	153	76	2 Lamp T8
ILWRK98LED8D	8'	80	14,067	149	13,976	148	13,976	148	98	2 Lamp T5
ILWRK98LED4WD	4'	80	14,130	147	14,130	147	14,130	147	98	4 Lamp T8
ILWRK130LED4WD	4'	80	17,821	141	17,621	140	17,621	140	130	6 Lamp T8
ILWRK190LED4WD	4'	80	27,480	144	27,480	144	27,480	144	190	6 Lamp T5

Independence Series Linear LED Vapor Tight



- Frosted injection-molded acrylic lens eliminates glare
- Uses durable latches to secure the lens to the housing



ORDERING INFORMATION

IVT		5L		45K		
PRODUCT SERIES	FIXTURE LENGTH	LUMEN PACKAGE	LENS OPTION	COLOR TEMP.	VOLTAGE	OPTIONS
IVT = Independence Vaportite	blank = 4 Feet	5L = 5,000 Lumen Package	Blank = Diffuse	4K = 4000K 45K = 4500K 5K = 5000K	Blank = 120-277	3C = 3' Cord (No Plug) 6C = 6' Cord (No Plug) 10C = 10' Cord (No Plug) 20C = 20' Cord (No Plug) EB = Emergency Back-Up

PERFORMANCE DATA

HOUSING	UNIT	CRI	4000K CCT		4500K CCT		5000K CCT		WATTAGE	REPLACES UP TO
			DELIVERED LUMENS	EFFICACY (LPW)	DELIVERED LUMENS	EFFICACY (LPW)	DELIVERED LUMENS	EFFICACY (LPW)		
IVT	5L	80	5,010	148	4,849	143	4,849	143	34	4L T8 FL

Scan QR code above for ordering format and more detailed information

THE INFORMATION YOU NEED - ALL IN ONE PLACE

Visit www.atlasled.com or scan QR code more information, including cut sheets, case studies, installation videos, instruction sheets, savings information, IES files, lighting calculation tools and more.



Origin Series Linear LED Vapor Tight



- Frosted injection-molded acrylic lens eliminates glare
- Uses durable latches to secure the lens to the housing
- Origin products are backed by the same US-based customer service



ORDERING INFORMATION

ORVT	4	4L		45K	
PRODUCT SERIES	FIXTURE LENGTH	LUMEN PACKAGE	LENS OPTION	COLOR TEMP.	VOLTAGE
ORVT = Origin Vapor Tight	4 = 4 Feet	4L = 4,500 Lumen Package	Blank = Diffuse	4K = 4000K	Blank = 120-277

PERFORMANCE DATA

HOUSING	UNIT	CRI	4000K CCT		WATTAGE	REPLACES UP TO
			DELIVERED LUMENS	EFFICACY (LPW)		
ORVT4	4L	80	4,500	113	40	2L T5 FL

Scan QR code above for more detailed information

Industrial Grade Stairwell Light

2' | 4'



- Cold rolled die formed steel housing
- Prismatic high-transmission lens
- Factory-installed ultrasonic motion sensor



ORDERING INFORMATION

SWL	2	2L	4K		US	
PRODUCT SERIES	LENGTH	LUMEN PACKAGE	COLOR TEMP.	VOLTAGE	SENSOR	OPTIONS
SWL = Stairwell Light	2 = 2' 4 = 4'	2L = 2,000 Lumens* 3L = 3,000 Lumens* 5L = 5,000 Lumens** 6L = 6,000 Lumens** 8L = 8,000 Lumens** * - Only available in 2' ** - Only available in 4'	35K = 3500K 4K = 4000K 5K = 5000K	Blank = 120-277 4 = 347-480V	US = Ultrasonic Sensor (Standard)	EB = 10W Emergency Backup

PERFORMANCE DATA

HOUSING	UNIT	CRI	3500K CCT		4000K CCT		5000K CCT		WATTAGE	REPLACES UP TO
			DELIVERED LUMENS	EFFICACY (LPW)	DELIVERED LUMENS	EFFICACY (LPW)	DELIVERED LUMENS	EFFICACY (LPW)		
SWL2	2L	80	1,918	119	1,968	123	2,032	127	16	70W MH
	3L	80	2,852	124	2,967	129	3,036	132	23	4L T8 FL
SWL4	5L	80	4,788	133	5,011	139	5,040	140	36	4L T8 FL
	6L	80	5,720	130	5,940	135	6,028	137	44	
	8L	80	7,750	125	8,044	129	8,184	132	62	

Scan QR code above for ordering format and more detailed information

THE INFORMATION YOU NEED - ALL IN ONE PLACE

Visit www.atlasled.com or scan QR code more information, including cut sheets, case studies, installation videos, instruction sheets, savings information, IES files, lighting calculation tools and more.



Classic Series LED Strips

4' | 8'



- Lightweight and durable 22-gauge post-painted housing
- Individually or in continuous row mounting.
- Frosted acrylic lens eliminates bright spots and provides high vertical illumination



ORDERING INFORMATION

ILS	4	3L	L	4K	
PRODUCT SERIES	FIXTURE LENGTH	LUMEN PACKAGE	LENS OPTION	COLOR TEMP.	VOLTAGE
ILS = LED Linear Industrial Strip	4 = 4 Feet 8 = 8 Feet	3L = 3,000 Lumen Package 5L = 5,000 Lumen Package 6L = 6,000 Lumen Package 8L = 8,000 Lumen Package	L = With Lens	35 = 3500K CCT 4 = 4000K CCT 5 = 5000K CCT	xC* = 3' Cord (No Plug) xT* = 3' 120V Cord & Plug xE* = 3' 208V Cord & Plug xF* = 3' 240V Cord & Plug xS* = 3' 277V Cord & Plug EB = Emergency Back-Up M = Motion Sensor IC = Integrated Control *x = 3 for 3' Cord; 6 for 6' cord, 10 for 10' cord; and 20 for 20' cord lengths

PERFORMANCE DATA

UNIT	FIXTURE LENGTH	CRI	3500K CCT		4000K CCT		5000K CCT		WATTAGE	REPLACES UP TO
			DELIVERED LUMENS	EFFICACY (LPW)	DELIVERED LUMENS	EFFICACY (LPW)	DELIVERED LUMENS	EFFICACY (LPW)		
ILS43LL	4'	80	3,041	135	3,032	134	3,242	143	23	70W MH
ILS45LL	4'	80	5,017	131	5,002	130	5,348	139	38	4L T8 FL
ILS46LL	4'	80	6,036	138	6,018	137	6,434	147	44	4L T8 FL
ILS48LL	4'	80	8,072	132	8,048	132	8,605	141	61	4L T8 FL
ILS88LL	8'	80	8,212	136	8,075	133	8,664	143	61	4L T8 FL

Scan QR code above for more detailed information

Origin Series LED Strips

2' | 4' | 8'



- Lightweight and durable 22-gauge post-painted housing
- High-brightness LEDs protected by a frosted lens
- Origin products are backed by the same US-based customer service



ORDERING INFORMATION

ORST	4	4L		4K	
PRODUCT SERIES	FIXTURE LENGTH	LUMEN PACKAGE	VOLTAGE	COLOR TEMP.	HOUSING COLOR
ORST = Origin Series Lensed Strip	2 = 2 ft 4 = 4 ft 8 = 8 ft	2L = 2,000 Lumens ¹ 4L = 4,000 Lumens ² 8L = 8,000 Lumens ³ <i>¹ = 2 ft only ² = 4 ft only ³ = 8 ft only</i>	Blank = 120-277V	4K = 4000K CCT	Blank = White

PERFORMANCE DATA

HOUSING	UNIT	CRI	4000K CCT		WATTAGE	REPLACES UP TO
			DELIVERED LUMENS	EFFICACY (LPW)		
ORST2	2L	80	2,564	128	20	70W MH
ORST4	4L	80	4,500	113	40	4L T8 FL
ORST8	8L	80	8,450	130	65	4L T8 FL

Scan QR code above for more detailed information

THE INFORMATION YOU NEED - ALL IN ONE PLACE

Visit www.atlasled.com or scan QR code more information, including cut sheets, case studies, installation videos, instruction sheets, savings information, IES files, lighting calculation tools and more.



Origin Series Field Adjustable Edge Lit Panels

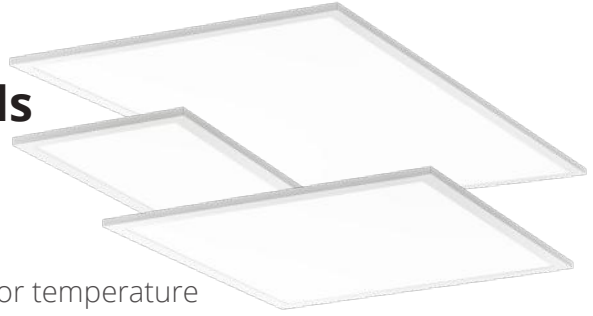

- Field adjustable lumen output and color temperature
- Quick connects for easy installation
- PMMA lens designed not to yellow

ORDERING INFORMATION

FAELP	24	LED		
PRODUCT SERIES	SIZE	LIGHT SOURCE	VOLTAGE	OPTIONS
FAELP = Field Adjustable Edge Lit Panel	14 = 1'x4' 22 = 2'x2' 24 = 2'x4'	LED = LED	U = Universal Voltage (120-277V) with 0-10v Dimming	EB = Emergency Back-Up

PERFORMANCE DATA

UNIT	FIXTURE LENGTH	CRI	SELECTABLE 3500K CCT		SELECTABLE 4000K CCT		SELECTABLE 5000K CCT		WATTAGE	REPLACES UP TO
			DELIVERED LUMENS	EFFICACY (LPW)	DELIVERED LUMENS	EFFICACY (LPW)	DELIVERED LUMENS	EFFICACY (LPW)		
FAELP14	1'x4'	>80	3,102	121	3,274	132	3,154	123	25	(2) F32-T8
			3,513	118	3,748	130	3,570	120	30	
			4,398	110	4,767	125	4,464	112	40	
FAELP22	2'x2'	>80	3,187	121	3,385	133	3,259	122	25	(3) F24-T5
			3,599	117	3,863	131	3,683	119	30	
			4,412	109	4,856	126	4,542	111	40	
FAELP24	2'x4'	>80	3,248	112	3,413	120	3,409	117	30	(4) F32-T8
			3,702	109	3,921	119	3,891	115	35	
			4,698	104	5,046	115	4,971	110	45	

Scan QR code above for more detailed information

Origin Series Field Adjustable Backlit Panels

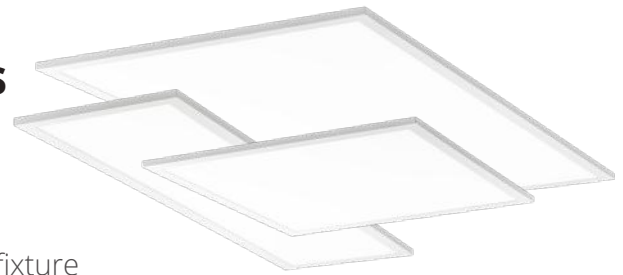

- Replace 9 standard panels with just 1 fixture
- Low-profile design makes installation quick and easy.
- Origin products are backed by the same US-based customer service

ORDERING INFORMATION

ORBLP	14	SEL	2-4L		
PRODUCT SERIES	SIZE	SELECTABLE	LUMEN PACKAGE	COLOR TEMP.	OPTIONS
ORBLP = Origin Series Back-Lit Panel	14 = 1'x4' 22 = 2'x2' 24 = 2'x4'	SEL = Selectable	2-4L = 2,000 - 4,000 Lumens Selectable ^{1,2} 3-6L = 3,000 - 6,000 Lumens Selectable ³ ¹ =1x4 only ² =2x2 only ³ =2x4 only	blank = Selectable 3500K, 4000K, 5000K	EB = Emergency Back-Up

PERFORMANCE DATA

UNIT	FIXTURE LENGTH	CRI	SELECTABLE 3500K CCT		SELECTABLE 4000K CCT		SELECTABLE 5000K CCT		WATTAGE	REPLACES UP TO
			DELIVERED LUMENS	EFFICACY (LPW)	DELIVERED LUMENS	EFFICACY (LPW)	DELIVERED LUMENS	EFFICACY (LPW)		
ORBLP14SEL	1'x4'	80	1,875	125	1,875	125	1,875	125	15	(2) F32-T8
			3,125	125	3,125	125	3,125	125	25	
			4,125	125	4,125	125	4,125	125	33	
ORBLP22SEL	2'x2'	80	1,875	125	1,875	125	1,875	125	15	(3) F24-T5
			3,125	125	3,125	125	3,125	125	25	
			4,125	125	4,125	125	4,125	125	33	
ORBLP24SEL	2'x4'	80	3,500	125	3,500	125	3,500	125	28	(4) F32-T8
			4,750	125	4,750	125	4,750	125	38	
			6,000	125	6,000	125	6,000	125	48	

Scan QR code above for more detailed information

THE INFORMATION YOU NEED - ALL IN ONE PLACE

Visit www.atlasled.com or scan QR code more information, including cut sheets, case studies, installation videos, instruction sheets, savings information, IES files, lighting calculation tools and more.



Origin Series Low Profile Troffers



- Replace 9 standard panels with just 1 fixture
- Low-profile design makes installation quick and easy.
- Origin products are backed by the same US-based customer service

ORDERING INFORMATION

TLP	24	S	4-6L	
PRODUCT SERIES	SIZE	SELECTABLE	LUMENS	OPTIONS
TLP = Low Profile Center Basket Troffer	14 = 1'x4' 22 = 2'x2' 24 = 2'x4'	S = Selectable	2-4L = 2,000 - 4,000 Lumens Selectable ^{1,2} 4-6L = 4,000 - 6,000 Lumens Selectable ³ ¹ = 1x4 only ² = 2x2 only ³ = 2x4 only	EB = Emergency Battery Back-up

PERFORMANCE DATA

UNIT	FIXTURE LENGTH	CRI	SELECTABLE 3500K CCT		SELECTABLE 4000K CCT		SELECTABLE 5000K CCT		WATTAGE	REPLACES UP TO
			DELIVERED LUMENS	EFFICACY (LPW)	DELIVERED LUMENS	EFFICACY (LPW)	DELIVERED LUMENS	EFFICACY (LPW)		
TLP14S2-4L	1'x4'	>80	2,609	130	2,715	137	2,591	129	20	(3) F24-T5
			3,262	130	3,433	137	3,239	129	25	
			3,838	125	3,993	136	3,811	124	30	
TLP22S2-4L	2'x2'	>80	3,804	135	3,933	143	3,891	137	30	(3) F24-T5
			4,378	133	4,531	140	4,472	135	35	
			4,853	122	4,998	127	4,982	125	40	
TLP24S4-6L	2'x4'	>80	4,188	140	4,315	148	4,259	143	32	(4) F32-T8
			5,586	133	5,675	143	5,400	135	42	
			6,428	127	6,760	137	6,490	128	52	

Scan QR code above for more detailed information



Linear High Bay & Wet Location Options & Accessories

Factory Installed Options







	SUFFIX #	DESCRIPTION
	IC	Integrated Control (120, 277V) <ul style="list-style-type: none"> - Omni-Directional Infrared Motion Sensor - Photocell Sensor for Daylight Harvesting - Bi-Level Switching
	M	360° Motion Sensor (120, 277V) <ul style="list-style-type: none"> - 2 Interchangeable, Application Specific Lenses (Aisle, High Bay, Low Bay)
	M2	360° Motion Sensor (208,240,480V) <ul style="list-style-type: none"> - 2 Interchangeable, Application Specific Lenses (Aisle, High Bay, Low Bay)
	L	Tool-less Snap On Lens <ul style="list-style-type: none"> - Frosted Acrylic Lens - 91% Efficiency - Provides Improved Visual Comfort - High Impact w/ Scratch Resistant Surface - Provides Wider, Smoother & Uniform Light Output - Protects LEDs
	W	Wireguard for Narrow High Bay - installed <ul style="list-style-type: none"> - Protects Fixtures from Hazards - Tool-less Entry - Hinges Down
	W	Wireguard for Wide High Bay - installed <ul style="list-style-type: none"> - Protects Fixtures from Hazards - Tool-less Entry - Hinges Down
	P	Pendant Mount <ul style="list-style-type: none"> - Accepts 3/4" Rigid Conduit - Single Point Mounting
	SP	10Kv Surge Protector

Factory Installed Cord Sets

	SUFFIX #	DESCRIPTION
	xC*	x' Cord
	xT*	x' 120V Plug
	xE*	x' 208V Plug
	xF*	x' 240V Plug
	xS*	x' 277V Plug

*x = 3 for 3' Cord; 6 for 6' cord, 10 for 10' cord and 20 for 20' cord lengths

Field Available Accessories

	CATALOG#	DESCRIPTION
	MS360	360° Motion Sensor (120, 277V)
	MS360-480	360° Motion Sensor (208, 240, 480V)
	MS360WL	Wet Location Motion Sensor (120, 277V)
	MS360WL-480	Wet Location Motion Sensor (208, 240, 480V)
	150-103WL45-4	45° Mounting Bracket (Pack of 2)
	150-103WL45-8	45° Mounting Bracket (Pack of 3)
	WGH33	Wireguard for Narrow 4' High Bay
	WGH36	Wireguard for Wide 4' High Bay
	CH36	36" Chain Set (Set of 2)
	CH36HFC	36" Chain Set w/ Hammer-On Flange
	CA36	36" Cable Set (Set of 2)
	PMK	Pendant Mount Kit for 4' High Bay
	PMK-2	Pendant Mount Kit for 2' High Bay
	80-SP	10Kv Surge Protection
	80-HS	Hook Set (2)

Scan QR code above for more detailed information

THE INFORMATION YOU NEED - ALL IN ONE PLACE

Visit www.atlasled.com or scan QR code more information, including cut sheets, case studies, installation videos, instruction sheets, savings information, IES files, lighting calculation tools and more.





PO Box 2348 Burlington, NC 27216
1406 S. Mebane Street Burlington, NC 27215
800-849-8485 | www.atlasled.com

452-152 012524