

# AREA LIGHTING & POLES

EAGLE - AREA LIGHTS | ORIGIN AREA LIGHTS | POLES



# Eagles Series Medium LED Area Light



**LUMEN SELECTABLE**  
- ☀️ +



- Multi-Mount Bracket Included
- Offers 180° of mounting angle adjustment.
- Both Type III and Type V optics are included in the box.



## ORDERING INFORMATION

ORA	SEL	15-22L			
PRODUCT SERIES	SELECTABLE	LUMEN PACKAGE	COLOR TEMP.	VOLTAGE	FIXTURE COLOR
ORA = Origin Area Light	SEL = Selectable	15-22L = 14,500 - 21,750 Lumens Selectable 30-43L = 29,000 - 43,500 Lumens Selectable	blank = Selectable 3000K, 4000K, 5000K	Blank = 120-277 4 = 347-480V	Blank = Bronze

### MULTI-MOUNT BRACKET



Square and round pole mount, trunnion mount, slipfitter mount included in carton.

### TOOL-FREE SWAPPABLE OPTICS



Type III optic is pre-installed.  
Type V included in the box.

## MULTIPLE DISTRIBUTION PATTERNS - ROTATABLE OPTICS

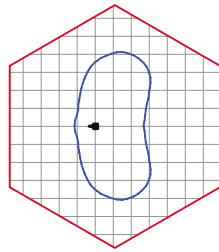

TYPE III

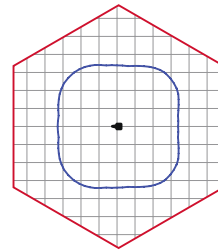

TYPE V

## PERFORMANCE DATA

LUMEN PACKAGE	DISTRIBUTION	CRI	3000K CCT		4000K CCT		5000K CCT		WATTAGE	REPLACES UP TO
			DELIVERED LUMENS	EFFICACY (LPW)	DELIVERED LUMENS	EFFICACY (LPW)	DELIVERED LUMENS	EFFICACY (LPW)		
<b>SELECTABLE</b>										
15-22L	T3	70	14,836	146	15,306	155	15,415	152	100	250W
	T5	70	15,390	152	15,908	159	16,104	157		
	T3	70	17,526	142	18,130	152	18,076	148	120	400W
	T5	70	17,979	148	18,670	157	18,817	153		
	T3	70	20,834	138	21,551	148	21,347	142	150	400W
	T5	70	22,349	142	23,287	152	23,205	145		
30-43L	T3	70	30,197	148	31,993	161	32,486	159	200	400W
	T5	70	30,514	152	32,318	164	32,996	163		
	T3	70	35,331	143	37,689	157	38,238	154	240	1000W
	T5	70	35,439	148	37,746	161	38,414	158		
	T3	70	41,560	138	44,839	154	45,503	151	300	1000W
	T5	70	43,145	143	45,695	157	46,111	152		

## THE INFORMATION YOU NEED - ALL IN ONE PLACE

Visit [www.atlasled.com](http://www.atlasled.com) or scan QR code more information, including cut sheets, case studies, installation videos, instruction sheets, savings information, IES files, lighting calculation tools and more.



# Eagles Series Small LED Area Light



**LUMEN SELECTABLE**  
-☀️+



- Easy to install, easy to maintain
- Optical Grade Individual Lenses
- Delivers Increased Footcandles



## ORDERING INFORMATION

SLPS	S	6-12L	T2	4K	VOLTAGE	COLOR RENDERING	FIXTURE COLOR	OPTIONS
PRODUCT SERIES	SELECTABLE	LUMEN PACKAGE	DISTRIBUTION	COLOR TEMP.				
SLPS = Small Eagle Series Area Light	blank = Fixed	6L = 6,000 Lumens 9L = 9,000 Lumens 12L = 12,000 Lumens	T2 = Type 2 T5 = Type 5 FT = Forward Throw T2L = Type 2 Rotated Left	3K = 3000K 4K = 4000K 45K = 4500K 5K = 5000K	Blank = 120-277 4 = 347/480	Blank = 70CRI	Blank = Bronze BK = Black SL = Silver WT = White	PR = 7 Pin Photocell Receptacle SP = Surge Protection IC = Integrated Motion Control* <i>*Only available in 120-277V / Not available on Selectable Units</i>
SLPS = Eagle Series Area Light	S = Selectable	6-12L = 6,000, 8,000, 12,000 Lumens Selectable	FTL = Forward Throw Rotated Left T2R = Type 2 Rotated Right FTR = Forward Throw Rotated Right					

## OPTIONS AND ACCESSORIES

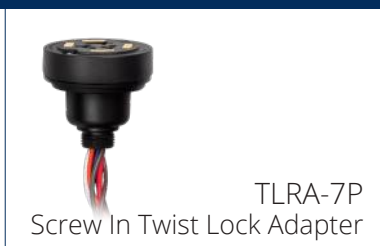
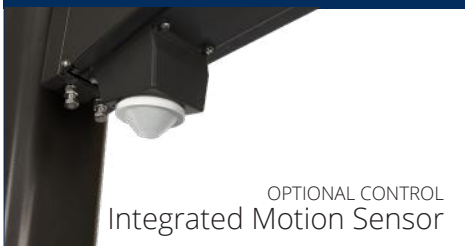

## INSTALLATION



## MULTIPLE DISTRIBUTION PATTERNS - ROTATABLE OPTICS

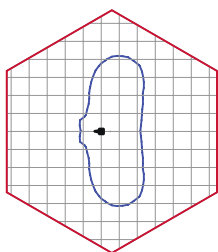

**TYPE II**

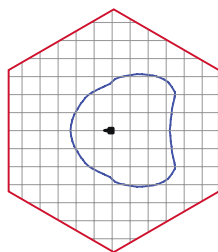

**TYPE FT**

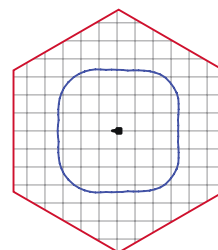

**TYPE V**

## PERFORMANCE DATA

HOUSING	UNIT	DISTRIBUTION	CRI	4000K CCT		4500K CCT		5000K CCT		WATTAGE	REPLACES UP TO
				DELIVERED LUMENS	EFFICACY (LPW)	DELIVERED LUMENS	EFFICACY (LPW)	DELIVERED LUMENS	EFFICACY (LPW)		
<b>SELECTABLE</b>											
SLPSS	6-12L	T2	70	6,036	143	6,036	143	6,036	143	42	175W MH
		FT	70	5,899	140	5,859	139	5,859	139		
		T5	70	5,812	138	5,812	138	5,812	138		
		T2	70	8,946	142	8,946	142	8,946	142	63	175W MH
		FT	70	8,743	138	8,684	137	8,684	137		
		T5	70	8,614	136	8,614	136	8,614	136		
		T2	70	11,755	137	11,755	137	11,755	137	86	250W MH
		FT	70	11,488	134	11,410	133	11,410	133		
T5	70	11,319	132	11,319	132	11,319	132				

HOUSING	UNIT	DISTRIBUTION	CRI	4000K CCT		4500K CCT		5000K CCT		WATTAGE	REPLACES UP TO
				DELIVERED LUMENS	EFFICACY (LPW)	DELIVERED LUMENS	EFFICACY (LPW)	DELIVERED LUMENS	EFFICACY (LPW)		
<b>FIXED</b>											
SLPS	6L	T2	70	6,297	154	6,288	153	6,288	153	41	175W MH
		FT	70	6,005	146	5,839	144	5,839	144		
		T5	70	6,025	147	6,016	147	6,016	147		
	9L	T2	70	9,041	144	8,859	142	8,859	142	63	175W MH
		FT	70	8,717	139	8,541	136	8,541	136		
		T5	70	8,639	138	8,465	135	8,465	135		
	12L	T2	70	12,028	136	11,822	133	11,822	133	89	250W MH
		FT	70	11,417	129	11,222	127	11,222	127		
		T5	70	11,578	131	11,380	129	11,380	129		

Scan QR code above for ordering format and more detailed information

## THE INFORMATION YOU NEED - ALL IN ONE PLACE

Visit [www.atlasled.com](http://www.atlasled.com) or scan QR code more information, including cut sheets, case studies, installation videos, instruction sheets, savings information, IES files, lighting calculation tools and more.



# Eagles Series Medium LED Area Light

**LUMEN SELECTABLE**  
- ☀️ +



- Easy to install, easy to maintain
- Optical Grade Individual Lenses
- Delivers Increased Footcandles



## ORDERING INFORMATION

SLPM	S	12-24L	T2	4K				
PRODUCT SERIES	SELECTABLE	LUMEN PACKAGE	DISTRIBUTION	COLOR TEMP.	VOLTAGE	COLOR RENDERING	FIXTURE COLOR	OPTIONS
SLPM = Eagle Series Area Light	S = Selectable	12-24L = 12,000- 24,000 Lumens Selectable 25-50L = 25,000-50,000 Lumens Selectable	T2 = Type 2 T3 = Type 3 T5 = Type 5 FT = Forward Throw T2L = Type 2 Rotated Left T3L = Type 3 Rotated Left FTL = Forward Throw Rotated Left T2R = Type 2 Rotated Right T3R = Type 3 Rotated Right FTR = Forward Throw Rotated Right	3K = 3000K 4K = 4000K 45K = 4500K 5K = 5000K	Blank = 120-277 4 = 347/480	Blank = 70CRI	Blank = Bronze BK = Black SL = Silver WT = White	PR = 7 Pin Photocell Receptacle SP = Surge Protection M = Motion

### OPTIONS AND ACCESSORIES



### INSTALLATION



## MULTIPLE DISTRIBUTION PATTERNS - ROTATABLE OPTICS

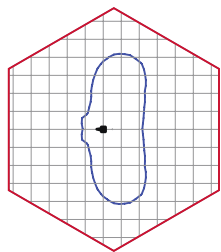

**TYPE II**

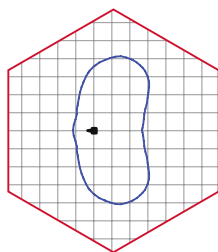

**TYPE III**

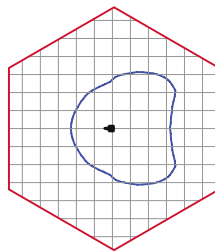

**TYPE FT**

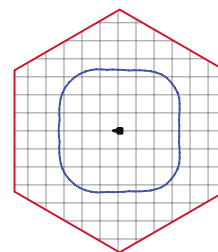

**TYPE V**

## PERFORMANCE DATA

HOUSING	UNIT	DISTRIBUTION	CRI	3000K CCT		4000K CCT		4500K CCT		5000K CCT		WATTAGE	REPLACES UP TO
				DELIVERED LUMENS	EFFICACY (LPW)	DELIVERED LUMENS	EFFICACY (LPW)	DELIVERED LUMENS	EFFICACY (LPW)	DELIVERED LUMENS	EFFICACY (LPW)		
<b>SELECTABLE</b>													
SLPMS	12-24L	T2	70	12,646	160	12,646	160	12,646	160	13,434	170	79	250W MH
		T3	70	25,220	148	12,646	160	12,646	160	13,508	171		
		FT	70	12,646	160	12,646	160	12,646	160	13,278	168		
		T5	70	12,646	160	12,646	160	12,646	160	13,541	172		
		T2	70	18,707	151	18,707	151	18,707	151	19,872	161	124	400W MH
		T3	70	18,707	151	18,707	151	18,707	151	19,982	161		
		FT	70	18,707	151	18,707	151	18,707	151	19,642	159		
		T5	70	18,707	151	18,707	151	18,707	151	20,032	162		
		T2	70	23,741	141	23,741	141	23,741	141	25,220	148	171	400W MH
		T3	70	23,741	141	23,741	141	23,741	141	25,359	149		
		FT	70	23,741	141	23,741	141	23,741	141	24,928	146		
		T5	70	23,741	141	23,741	141	23,741	141	25,422	149		
	25-50L	T2	70	26,536	168	26,054	165	26,526	168	13,434	170	158	400W MH
		T3	70	26,535	168	26,052	165	26,524	168	13,508	171		
		FT	70	25,884	164	25,414	161	25,874	164	13,278	168		
		T5	70	26,448	167	25,967	164	26,438	167	13,541	172		
		T2	70	38,675	158	37,972	155	38,659	158	19,872	161	245	1000W MH
		T3	70	38,672	158	37,969	155	38,656	158	19,982	161		
		FT	70	37,725	154	37,039	151	37,709	154	19,642	159		
		T5	70	38,546	157	37,846	154	38,531	157	20,032	162		
T2	70	48,164	145	47,289	142	48,145	145	25,220	148	332	1000W MH		
T3	70	48,161	145	47,285	142	48,141	145	25,359	149				
FT	70	46,981	142	46,127	139	46,962	141	24,928	146				
T5	70	48,004	145	47,132	142	47,985	145	25,422	149				

Scan QR code above for ordering format and more detailed information

### THE INFORMATION YOU NEED - ALL IN ONE PLACE

Visit [www.atlasled.com](http://www.atlasled.com) or scan QR code more information, including cut sheets, case studies, installation videos, instruction sheets, savings information, IES files, lighting calculation tools and more.



# Eagles Series Medium LED Area Light



- Easy to install, easy to maintain
- Optical Grade Individual Lenses
- Delivers Increased Footcandles



## ORDERING INFORMATION

SLPM	S	12-24L	T2	4K				
PRODUCT SERIES	SELECTABLE	LUMEN PACKAGE	DISTRIBUTION	COLOR TEMP.	VOLTAGE	COLOR RENDERING	FIXTURE COLOR	OPTIONS
SLPM = Eagle Series Area Light	blank = Fixed	6L = 6,000 Lumens 9L = 9,000 Lumens 12L = 12,000 Lumens 18L = 18,000 Lumens 24L = 24,000 Lumens 30L = 30,000 Lumens 36L = 36,000 Lumens 43L = 43,000 Lumens 50L = 50,000 Lumens	T2 = Type 2 T3 = Type 3 T5 = Type 5 FT = Forward Throw T2L = Type 2 Rotated Left T3L = Type 3 Rotated Left FTL = Forward Throw Rotated Left T2R = Type 2 Rotated Right T3R = Type 3 Rotated Right FTR = Forward Throw Rotated Right	3K = 3000K 4K = 4000K 45K = 4500K 5K = 5000K	Blank = 120-277 4 = 347/480	Blank = 70CRI	Blank = Bronze BK = Black SL = Silver WT = White	PR = 7 Pin Photocell Receptacle SP = Surge Protection IC = Integrated Motion Control* M = Motion  *Only available in 120-277V

## OPTIONS AND ACCESSORIES



## INSTALLATION





## MULTIPLE DISTRIBUTION PATTERNS - ROTATABLE OPTICS

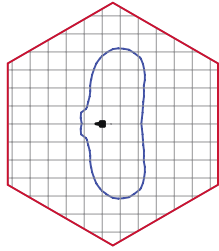

**TYPE II**

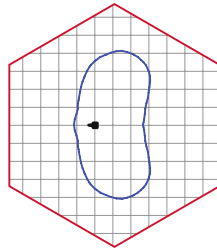

**TYPE III**

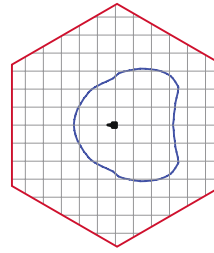

**TYPE FT**

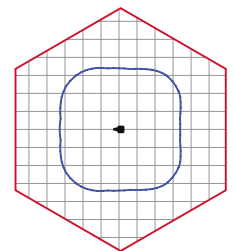

**TYPE V**

## PERFORMANCE DATA

HOUSING	UNIT	DISTRIBUTION	CRI	3000K CCT		4000K CCT		4500K CCT		5000K CCT		WATTAGE	REPLACES UP TO
				DELIVERED LUMENS	EFFICACY (LPW)	DELIVERED LUMENS	EFFICACY (LPW)	DELIVERED LUMENS	EFFICACY (LPW)	DELIVERED LUMENS	EFFICACY (LPW)		
<b>FIXED</b>													
SLPM	6L	T2	70	5,908	153	6,067	158	6,093	159	6,152	160	39	175W MH
		T3	70	5,824	151	5,981	155	6,006	155	6,065	157		
		FT	70	5,712	148	5,866	152	5,891	153	5,948	154		
		T5	70	5,848	152	6,005	156	6,031	156	6,090	158		
	9L	T2	70	9,155	159	9,401	163	9,442	164	9,533	166	58	175W MH
		T3	70	9,082	158	9,326	162	9,366	163	9,457	164		
		FT	70	8,866	154	9,104	158	9,144	159	9,232	160		
		T5	70	9,086	158	9,330	162	9,370	163	9,461	164		
	12L	T2	70	10,962	148	11,513	154	11,513	154	11,602	156	75	250W MH
		T3	70	11,452	154	12,028	161	12,028	161	12,121	163		
		FT	70	11,335	153	11,905	159	11,905	159	12,601	169		
		T5	70	11,571	156	12,153	162	12,153	162	12,247	164		
	18L	T2	70	17,840	155	19,506	160	18,509	152	18,509	152	122	400W MH
		T3	70	17,810	155	19,489	160	18,493	152	18,493	152		
		FT	70	17,340	151	19,182	157	18,201	149	18,201	149		
		T5	70	17,820	155	19,650	161	18,645	153	18,645	154		
	24L	T2	70	23,640	148	25,447	149	24,146	141	24,146	141	171	400W MH
		T3	70	23,620	148	25,425	149	24,125	141	24,125	141		
		FT	70	23,030	144	25,025	146	23,745	139	23,745	139		
		T5	70	23,660	148	25,635	150	24,324	142	24,324	142		
	30L	T2	70	29,450	140	29,395	166	28,859	164	28,859	164	177	750W MH
		T3	70	29,440	140	29,759	168	29,216	165	29,216	165		
		FT	70	28,750	137	29,393	166	28,857	163	28,857	163		
		T5	70	29,470	141	29,920	169	29,374	166	29,374	166		
	36L	T2	70	35,260	133	35,542	162	34,796	159	34,796	159	219	1000W MH
		T3	70	35,220	133	35,603	162	34,856	159	34,856	159		
		FT	70	34,490	131	35,032	160	34,297	157	34,297	157		
		T5	70	35,200	133	35,323	160	34,582	157	34,582	157		
	43L	T2	70	42,200	121	41,750	152	41,258	150	41,258	150	275	1000W MH
		T3	70	41,940	120	42,070	153	41,575	151	41,575	151		
		FT	70	41,300	118	41,617	151	41,127	150	41,127	150		
		T5	70	41,970	120	42,470	154	41,970	152	41,970	152		
50L	T2	70	n/a	n/a	48,821	147	47,962	144	47,962	144	333	1000W MH	
	T3	70	n/a	n/a	49,190	148	48,324	145	48,324	145			
	FT	70	n/a	n/a	47,891	144	47,048	142	47,048	142			
	T5	70	n/a	n/a	49,524	149	48,652	146	48,652	146			

Scan QR code above for ordering format and more detailed information

### THE INFORMATION YOU NEED - ALL IN ONE PLACE

Visit [www.atlasled.com](http://www.atlasled.com) or scan QR code more information, including cut sheets, case studies, installation videos, instruction sheets, savings information, IES files, lighting calculation tools and more.



# Eagles Series LED Area Light

Die Cast Aluminum Housing

Low Profile

External Air Flow Fins Dissipate Heat

Optional 7-Pin Controls Receptacle

Optional Surge Protector

Separate Driver Compartment for Cooler Operation & Longer Driver Life

Dimming

Advanced One Piece Optics with Multiple Distributions

- Type II
- Type III
- Type V
- Forward Throw
- Rotatable Optics

160+ Lumens per Watt

Labor Saving - Quick Mount Universal Bracket System Fits Any Pole

**PHILIPS ADVANCE**  
Quality LED Drivers

**200,000+ HOURS**

**UL LISTED**

**COLOR OPTIONS**

Bronze

Black

Silver

White

\*The majority of Atlas Lighting Products are assembled in USA facilities by an American Workforce utilizing both Domestic and Foreign components. | \*Qualifies for Buy American under ARRA



# Area Lighting Universal Bracket System

**FITS ANY POLE**

## Round Pole Adapter

	CATALOG#	DESCRIPTION	FINISH
	500-SLPMRPA	Round Pole Bracket	Bronze

Mounting Cleat Included with Fixture

## Square Pole Tenon Adapter - Up to 4 @ 90°

	CATALOG#	DESCRIPTION	FINISH
	500-SPTBZ	For Square Poles w/ Tenon	Bronze

Mounting Cleat Included with Fixture

## Square or Round Pole w/ Tenon - Up to 4 @ 90°

	CATALOG#	DESCRIPTION	FINISH
	500-RPT90BZ	For Tenon Up to 4 @ 90°	Bronze

Mounting Cleat Included with Fixture

## Square or Round Pole w/ Tenon - Up to 3 @ 120°

	CATALOG#	DESCRIPTION	FINISH
	500-RPT120BZ	For Tenon 3 @ 120°	Bronze

Mounting Cleat Included with Fixture

## Round Pole Top Adapter - Up to 4 @ 90°

	CATALOG#	DESCRIPTION	FINISH
	500-RPT-243490BZ	2.3" - 3.4" Pole Top O.D.	Bronze
	500-RPT-35490BZ	3.5" - 4" Pole Top O.D.	Bronze

Mounting Cleat Included with Fixture

## Round Pole Top Adapter - Up to 3 @ 120°

	CATALOG#	DESCRIPTION	FINISH
	500-RPT-2434120BZ	2.3" - 3.4" Pole Top O.D.	Bronze

Mounting Cleat Included with Fixture

## Wall Brackets

	CATALOG#	DESCRIPTION	FINISH
	500-WBBZ	Wall Mount Bracket	Bronze

Note: Not to be used as junction box.

## Wooden Pole Bracket

	CATALOG#	DESCRIPTION	FINISH
	500-WPBBZ	Wooden Pole Bracket	Bronze

Mounts to wood poles 8"-12" in diameter  
Note: Not to be used as junction box.

## Spoke Arm Brackets

	CATALOG#	DESCRIPTION	FINISH
	500-SAB21	Spoke Arm Bracket for SLP22	Bronze

## Angled Bracket

	CATALOG#	DESCRIPTION	FINISH
	500-AAB	Angled Bracket for SLP	Bronze

Note: All brackets are available in bronze, black, silver or white finishes.



Scan QR code above for more detailed information

**UNIVERSAL BRACKET SYSTEM**



Scan QR code to view video

**CASE STUDIES**

Scan QR code to view brochure

## THE INFORMATION YOU NEED - ALL IN ONE PLACE

Visit [www.atlasled.com](http://www.atlasled.com) or scan QR code more information, including cut sheets, case studies, installation videos, instruction sheets, savings information, IES files, lighting calculation tools and more.



# Poles

## American Made

Experience complete versatility, fast availability, and unmatched durability

## Complete Versatility

Endless Options, Made to Order

Completely configurable: choose from a wide variety of materials, finishes, sizes and styles to best suit your application and budget.



- Steel, Aluminum or Fiberglass
- Heights from under 10' to greater than 39' and everything in between
- Round, Square, Straight, Tapered, Hinged or Decorative

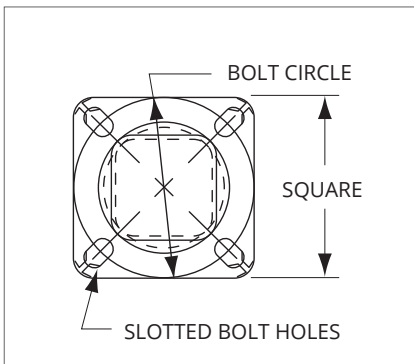

Wide offering of base plates with large range of customization to accommodate existing anchor bolts in retrofit applications.



## Fast Availability

### Industry-Leading Lead Times

Atlas Poles ship as soon as 5 days from the point of ordering. Our customer service representatives will walk you through the pole configuration process to ensure accuracy and quick order submission



## Unmatched Durability

### Stands Up to Harsh Environments

Designed and engineered for durability and provided as standard with our oven-baked DuraGrip Protection System. Also available with Atlas' proprietary DuraGrip+ Protection System for unmatched corrosion protection and extended warranty.

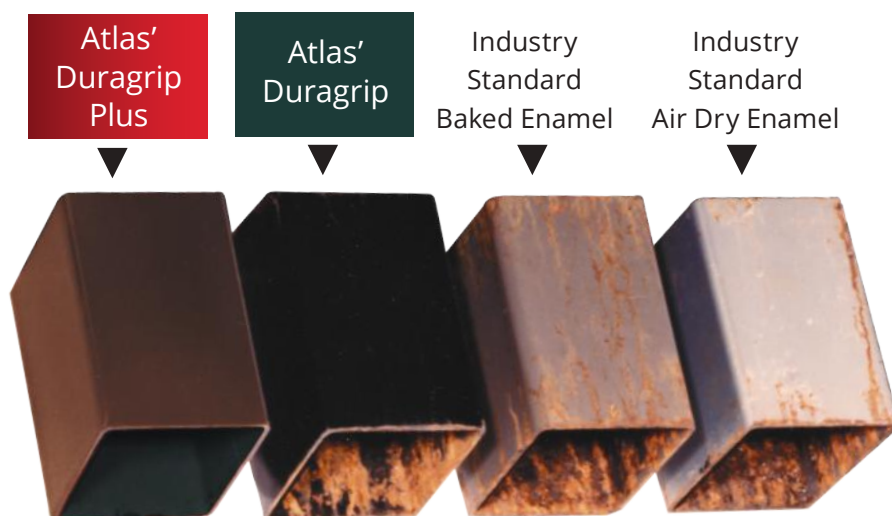

Poles After 1000hrs of Salt Spray Test

## THE INFORMATION YOU NEED - ALL IN ONE PLACE

Visit [www.atlasled.com](http://www.atlasled.com) or scan QR code more information, including cut sheets, case studies, installation videos, instruction sheets, savings information, IES files, lighting calculation tools and more.



# Area Lighting Poles



- Steel, Aluminum, Concrete, Fiberglass
- Square, Round, Straight, Tapered, etc.



THE FOLLOWING SQUARE STRAIGHT STEEL POLES ARE PART OF OUR QUICK SHIP PROGRAM:

PART #	HEIGHT	WIDTH	WALL THICKNESS
<b>DRILLED</b>			
SSS12411BZQSLB5	12'	4"	11 gauge
SSS15411BZQSLB5	15'	4"	11 gauge
SSS20411BZQSLB5	20'	4"	11 gauge
SSS25411BZQSLB5	25'	4"	11 gauge
<b>TENON TOP</b>			
SSS20411TBZQSLB	20'	4"	11 gauge
SSS25411TBZQSLB	25'	4"	11 gauge

Scan QR code above for ordering format and more detailed information

- All Poles Ship Within (2) Business Days After Order Is Placed
- All Poles Drilled For (4) Fixtures At 90°\*
- All Poles Supplied With (3) Sets Of Plugs For Unused Holes\*
- All Poles Standard Bronze
- Maximum Of (10) Poles Per Order On All Quick Ship Orders
- Anchor Bolts Are Sent Same Day As Order Is Placed

\*For drilled poles only. Tenon top not included.

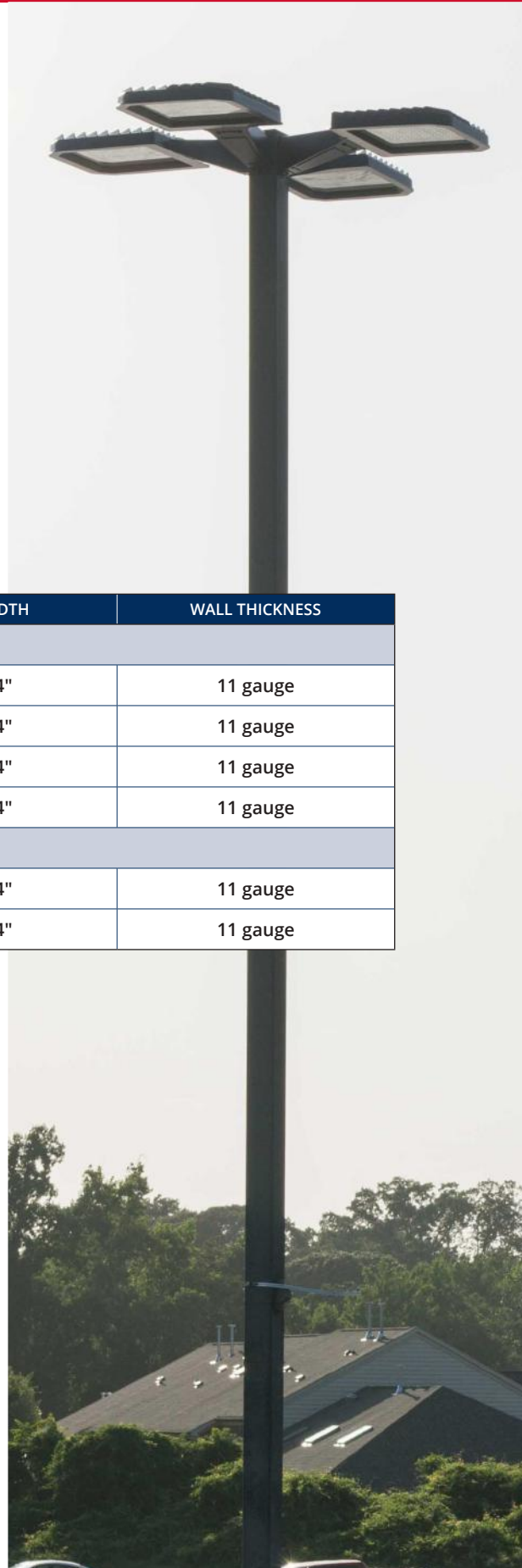

# Dual Deal Luminaire/Pole Combo



## Simple & Easy

Atlas offers our top area light paired with our highest quality poles in a deal that offers



## EAGLE/POLE COMBO

HOUSING	UNIT	DISTRIBUTION	CRI	4000K CCT		4500K CCT		5000K CCT		WATTAGE	REPLACES UP TO
				DELIVERED LUMENS	EFFICACY (LPW)	DELIVERED LUMENS	EFFICACY (LPW)	DELIVERED LUMENS	EFFICACY (LPW)		
PXSLPS	9L	FT	70	8,717	139	8,541	136	8,541	136	63	175W
		T5	70	8,639	138	8,465	135	8,465	135		
	12L	FT	70	11,417	129	11,222	127	11,222	127	89	250W
		T5	70	11,578	131	11,380	129	11,380	129		
PXSLPM	18L	T3	70	18493	152	18493	152	18,546	161	122	400W MH
		FT	70	18201	149	18201	149	18,056	157		
		T5	70	18645	153	18645	154	18,556	161		
	24L	T3	70	24125	141	24125	141	24,596	154	171	400W MH
		FT	70	23745	139	23745	139	23,981	150		
		T5	70	24324	142	24324	142	24,637	154		
	43L	T3	70	43,068	124	43,253	124	43,672	125	275	1000W MH
		FT	70	42,411	122	42,593	122	43,006	123		
		T5	70	43,099	124	43,284	124	43,703	125		
	50L	T3	70	49190	148	48324	145	48324	145	333	1000W MH
		FT	70	47891	144	47048	142	47048	142		
		T5	70	49524	149	48652	146	48652	146		

Scan QR code above for more detailed information

## THE INFORMATION YOU NEED - ALL IN ONE PLACE

Visit [www.atlasled.com](http://www.atlasled.com) or scan QR code more information, including cut sheets, case studies, installation videos, instruction sheets, savings information, IES files, lighting calculation tools and more.





# Atlas

★ Lighting Products®

PO Box 2348 Burlington, NC 27216  
1406 S. Mebane Street Burlington, NC 27215  
800-849-8485 | Fax: 1-855-847-2794  
[www.atlasled.com](http://www.atlasled.com)

452-223 071624